

PAINEL HOME PITANGA

V-1 26/01/2021

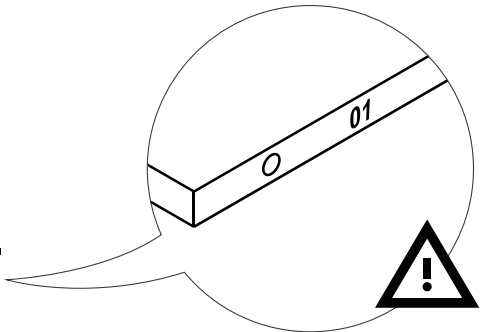
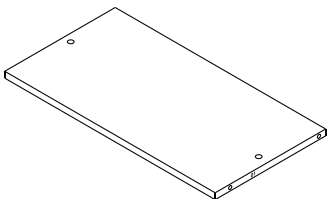
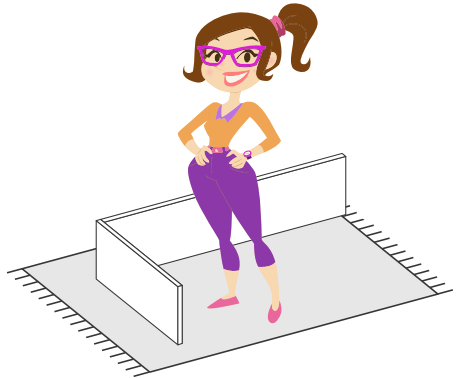
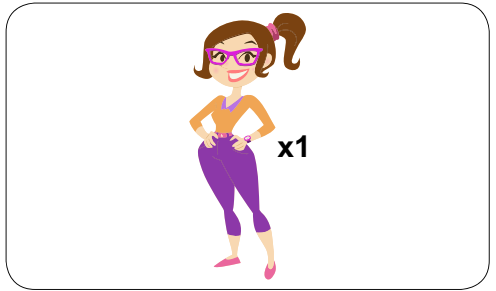
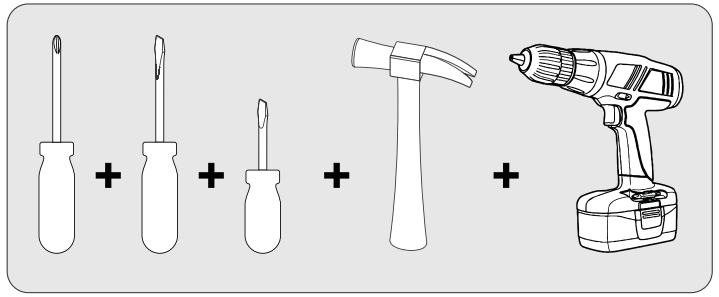
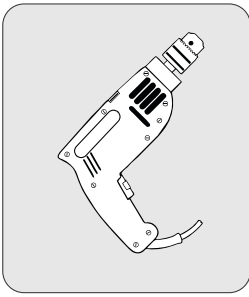

Nossos produtos são garantidos por 90 dias contra defeitos de fabricação. Ao constatar um problema coberto pela garantia, entre em contato com a loja onde o produto foi comprado. Ela estará capacitada para atendê-lo da melhor forma diante de cada caso. Reclamações de garantia somente poderão ser atendidas se o termo de garantia for apresentado no ato de reivindicação, acompanhado de sua nota fiscal de compra.

Nuestros productos están garantidos contra defectos de fabricación por 90 días, a partir de la compra.

Exclusões

- Desgaste natural ou danos causados por água, maresia, ferrugem, incêndio, calor, cupins e pragas em geral
- Montagem, manutenção e uso

A Linea Brasil não autoriza nenhuma pessoa, loja ou entidade assumir em seu nome qualquer outra garantia que não conste no certificado. A fabricante reserva-se no direito de efetuar nos produtos eventuais modificações que considerar necessárias, sem prejudicar as características essenciais. Os produtos terão peças

Exclusiones

- Desgaste natural o daños causados por agua, mares, maresia, incendios, calor, termitas y plagas en general
- Montaje, mantenimiento y uso inadecuado

Importante / Linea Brasil no autoriza a ninguna persona, tienda o entidad a asumir en su nombre cualquier otra garantía que no figure en el certificado. El fabricante se reserva el derecho de efectuar en los productos eventuales modificaciones que considere necesarias, sin perjudicar

Exclusions

- Natural wear or damage caused by water, sea, rust, fire, heat, termites and plagues in general
- Assembly, maintenance and improper use

Important / Linea Brasil does not authorize any person, store or entity to assume on its behalf any other warranty that does not appear on the certificate. The manufacturer reserves the right to make in the products any modifications that it considers necessary without

INSTRUÇÕES DE LIMPEZA E CONSERVAÇÃO

CLEAN AND PRESERVATION INSTRUCTURE / INSTRUCCIONES PARA LA LIMPIEZA Y CONSERVACION

Para retirar pó, utilize um pano seco, espanador ou aspirador. Se necessário para uma limpeza mais efetiva, utilize um pano levemente úmido com água. Finalize com uma flanela limpa e seca.

To take dirty, use a dry cloth, duster or vacuum. If necessary to take the dust, use a wet cloth. Finish with a clean and dry flannel.

Para eliminar el polvo, utilice un paño seco, mopa o la aspiradora. Si es necesario para una limpieza más eficaz, con paño ligeramente humedecido con agua. Terminar con un paño limpio y seco.



! IMPORTANTE / IMPORTANT / IMPORTANTE



Não utilize produtos abrasivos como álcool e detergentes, como também esponjas rígidas ou palhas de aço na limpeza dos móveis.

Do not use abrasives such as alcohol and detergent, taugh soaker also steel wool to clean the furniture.

No use limpiadores abrasivos como alcohol y detergentes, así como esponjas rígidas o lana de acero para limpiar los muebles.



Proteja a superfície do móvel de objetos que transmitam calor ou umidade.

Protect the surface of the furniture against objects that can pass heat and humidity.

Proteja la superficie del mueble de objetos que transmitan calor o humedad.



Evitar o contato de água e produto de limpeza com o rodapé do produto, pois poderá danificá-lo.

Avoid the contact of water and cleaning products with baseboard, cause it should damage your product.

Evitar el contacto con agua y producto de limpieza con el rodapié del producto, pues poderá dañarlo.



Procure sempre utilizar flanela limpa e seca para limpeza.

Try always to use a clean and dry flannel to cleaning.

Busque siempre utilizar franela limpia y seca para la limpieza.

Cuidado com objetos pontiagudos, eles podem arranhar a superfície das portas e tampo.

Take care with sharp objects, they can scratch the door lid surface.

Cuidado con objetos afilados, ellos pueden rayar la superficie de las puertas y la tapa.

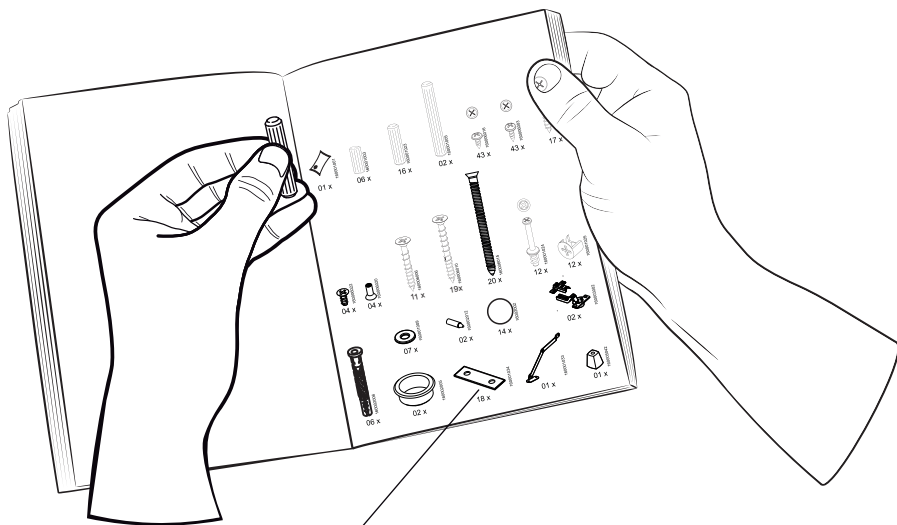

Preste Atenção! ¡Preste atención! Attention!



As ferragens dos nossos manuais são sempre apresentadas nas mesmas proporções da peça na vida real.

Los accesorios de nuestros manuales siempre se presentan en las mismas proporciones que la pieza en la vida real.

The accessories in our manuals are always presented in the same proportions as the spare part

Símbolos: Símbolos: Symbols:



- + Parafuso Phillips
- Parafuso Fenda
- Parafuso Allen

- + Tomillo Phillips
- Tomillo Ranurado
- Tomillo Allen

- + Philips screw
- Slotted Screw
- Allen screw

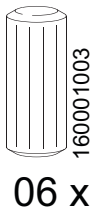

160001003

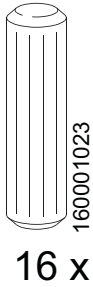

160001023

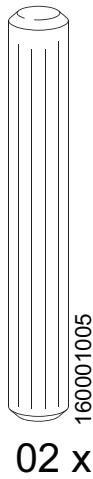

160001005



160006016



160006003

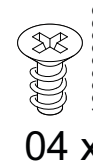

160006022

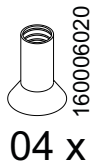

160006020

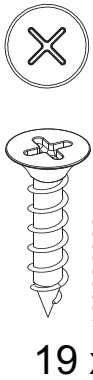

160006008

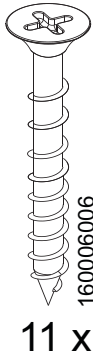

160006006

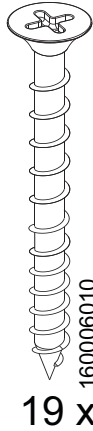

160006010

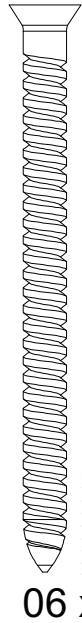

160006015

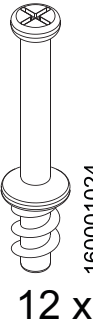

160001024

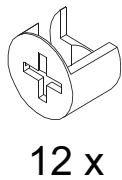

160001025

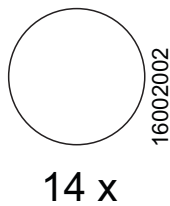

16002002

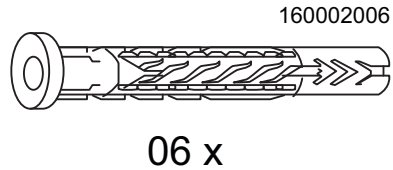

160002006

1:1

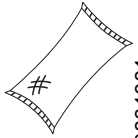

160001001

01 x

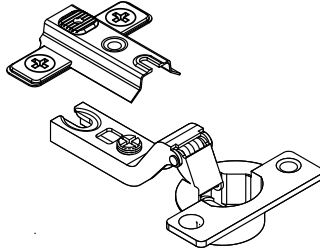

160003002

02 x

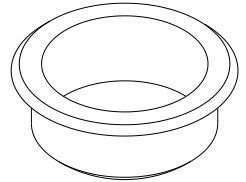

160002005

02 x

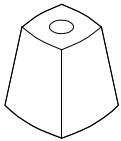

160005042

01 x

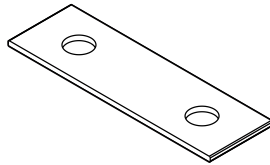

160001034

18 x

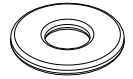

160001009

07 x

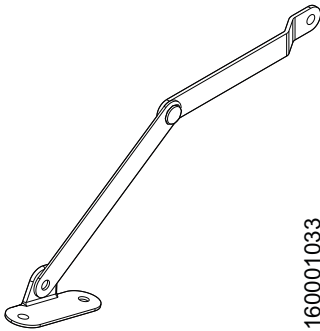

160001033

01 x

1

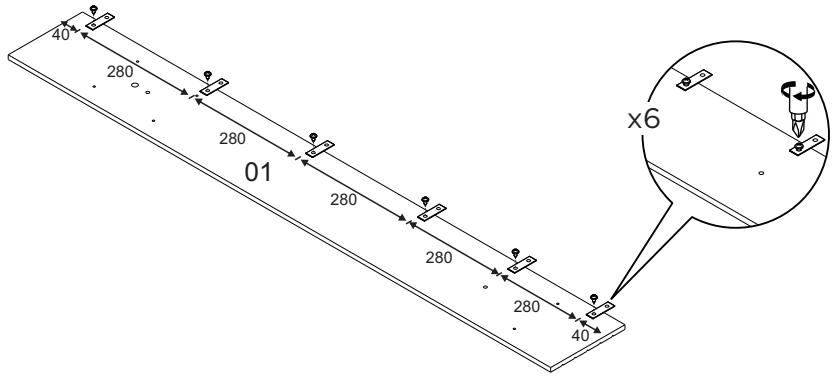
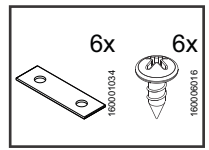

2

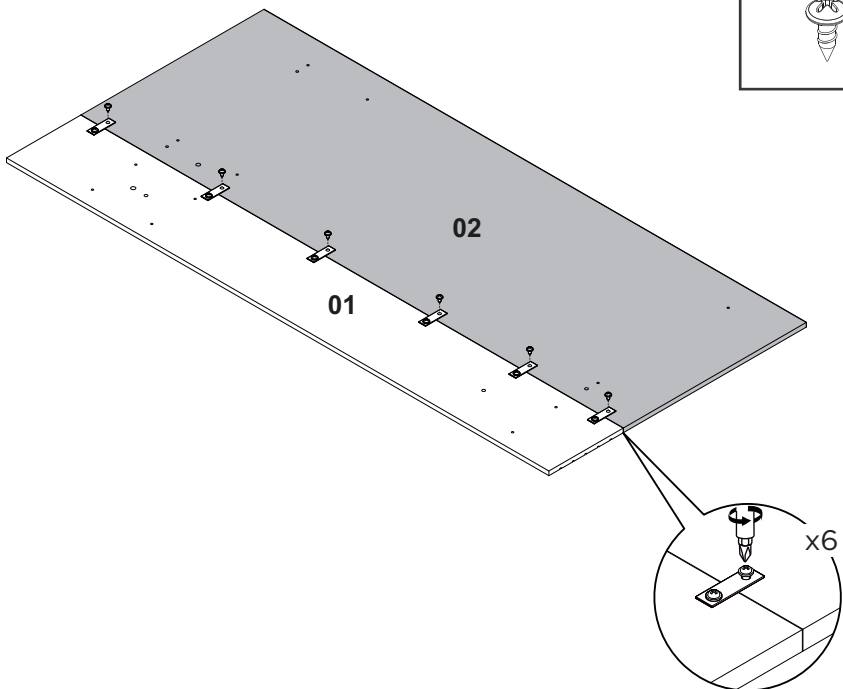
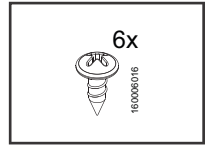

3

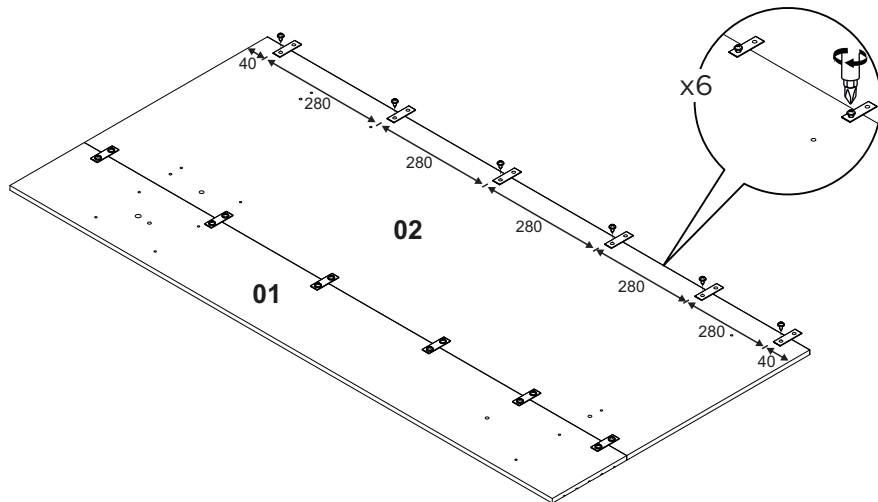
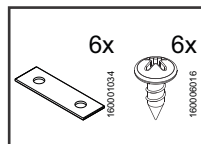

4

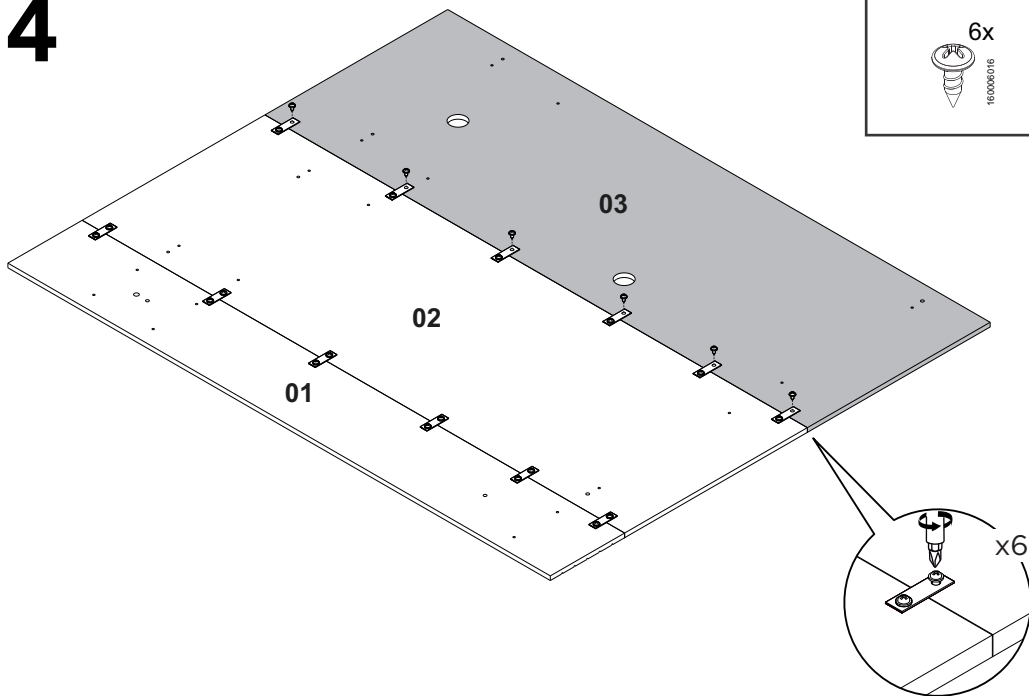
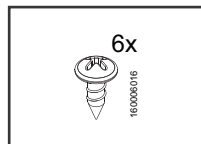

5

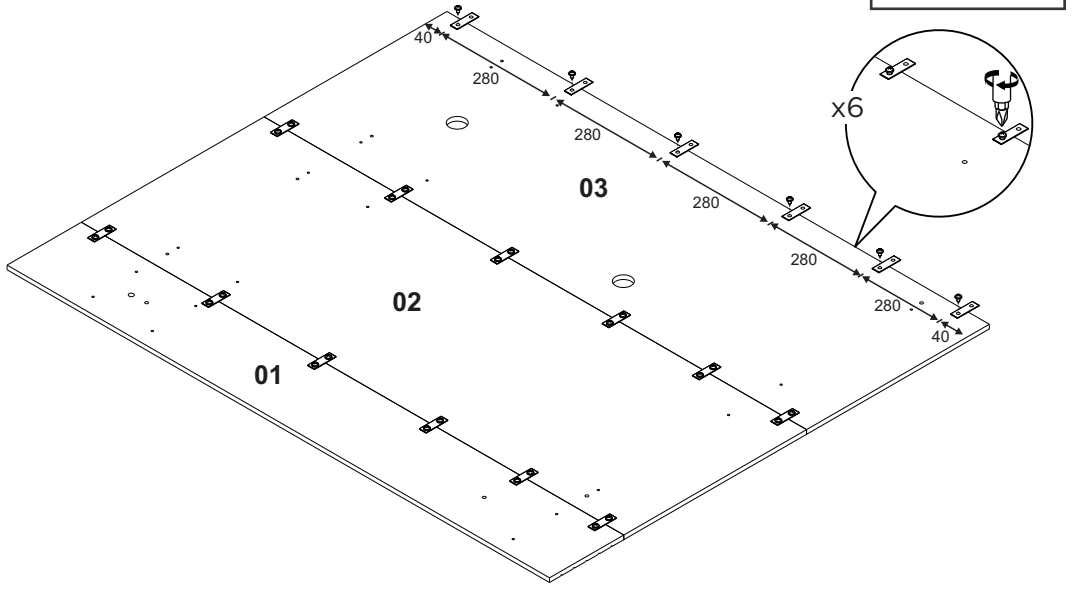

6

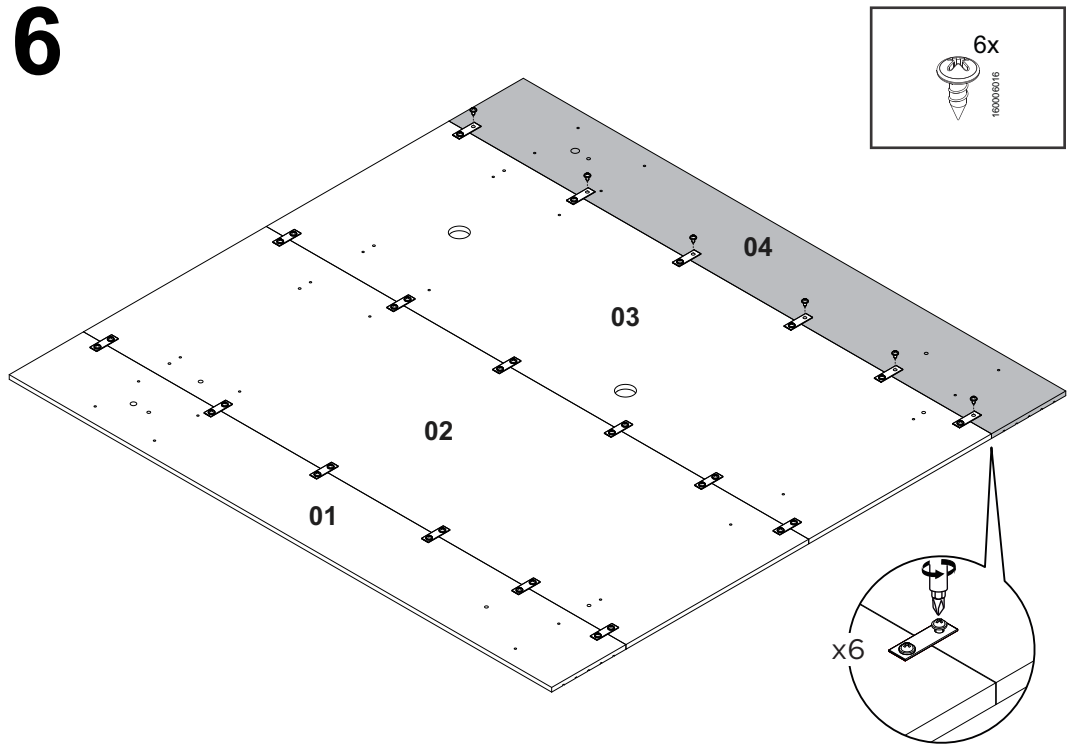

7

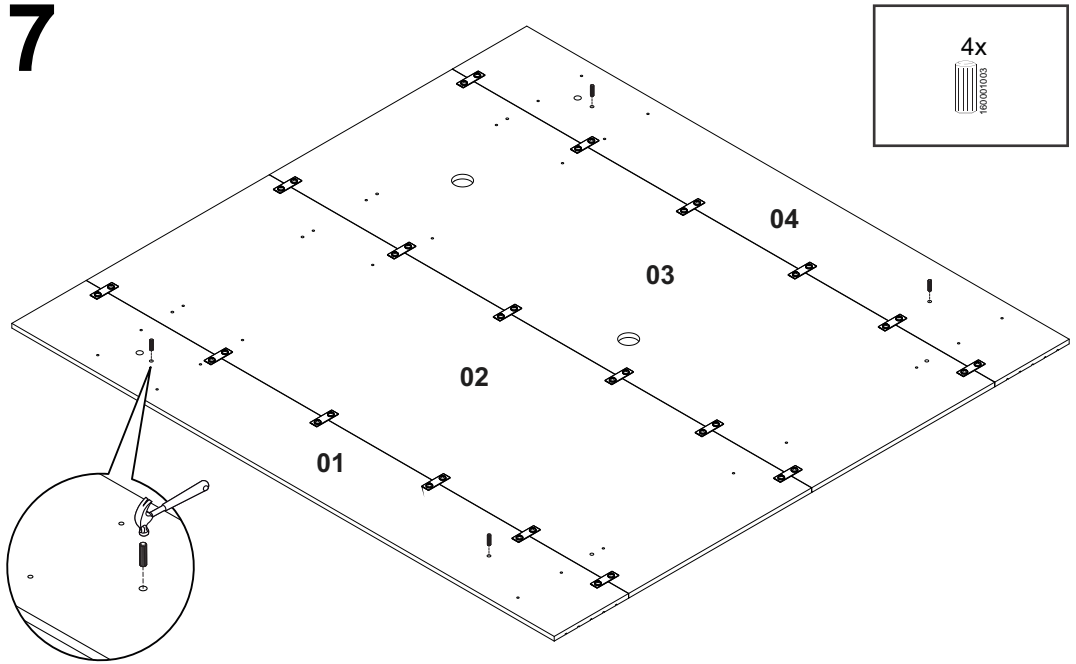

8

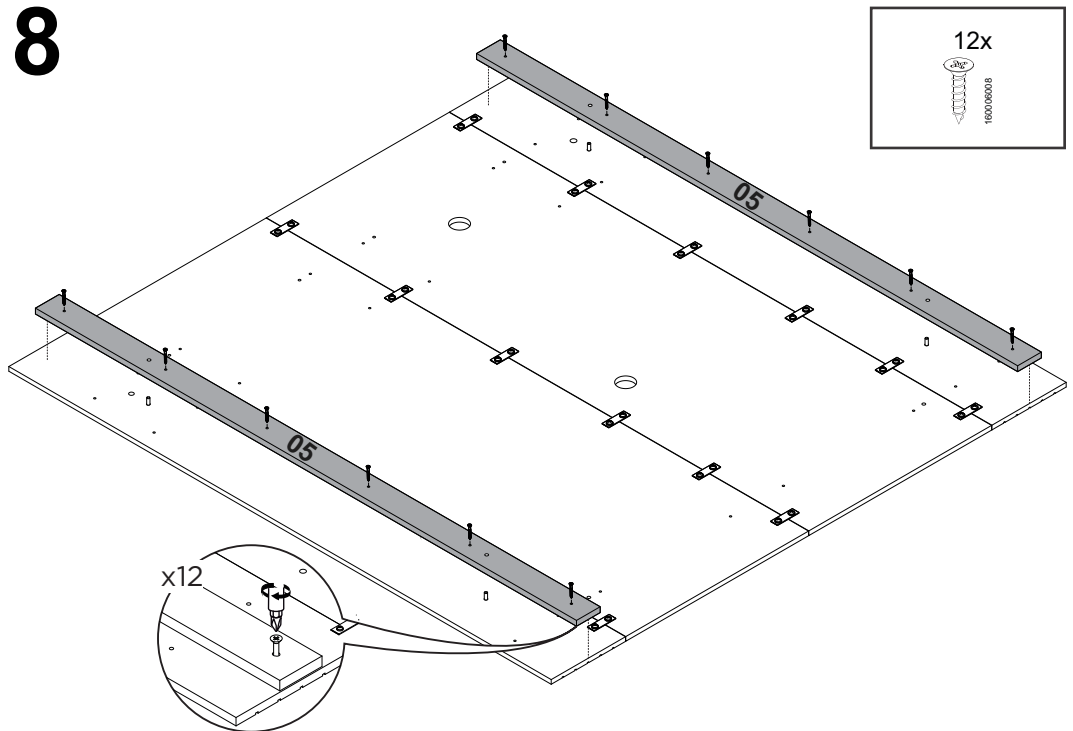

9

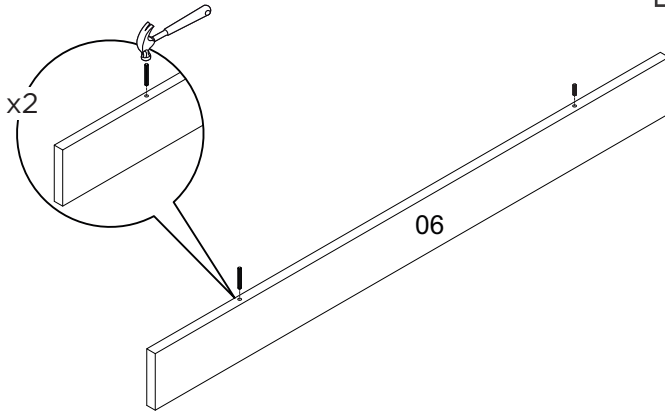
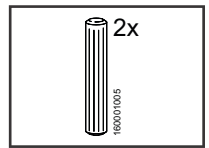

10

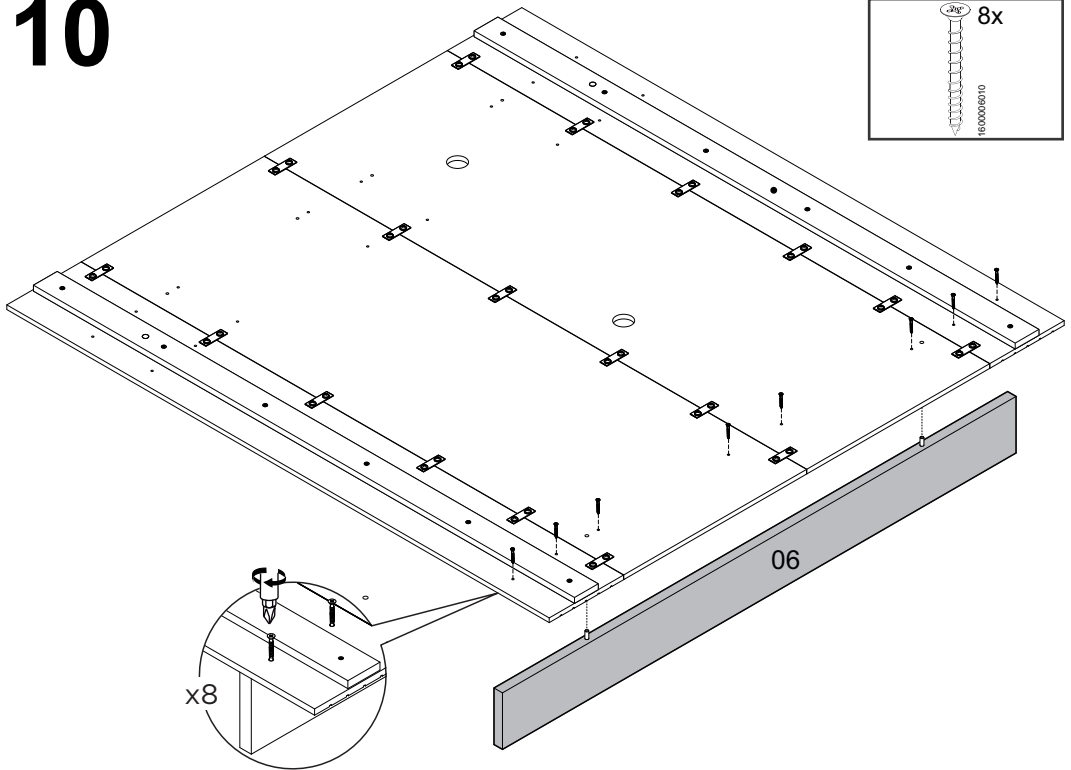
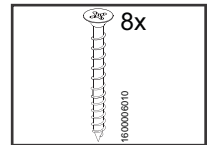

11

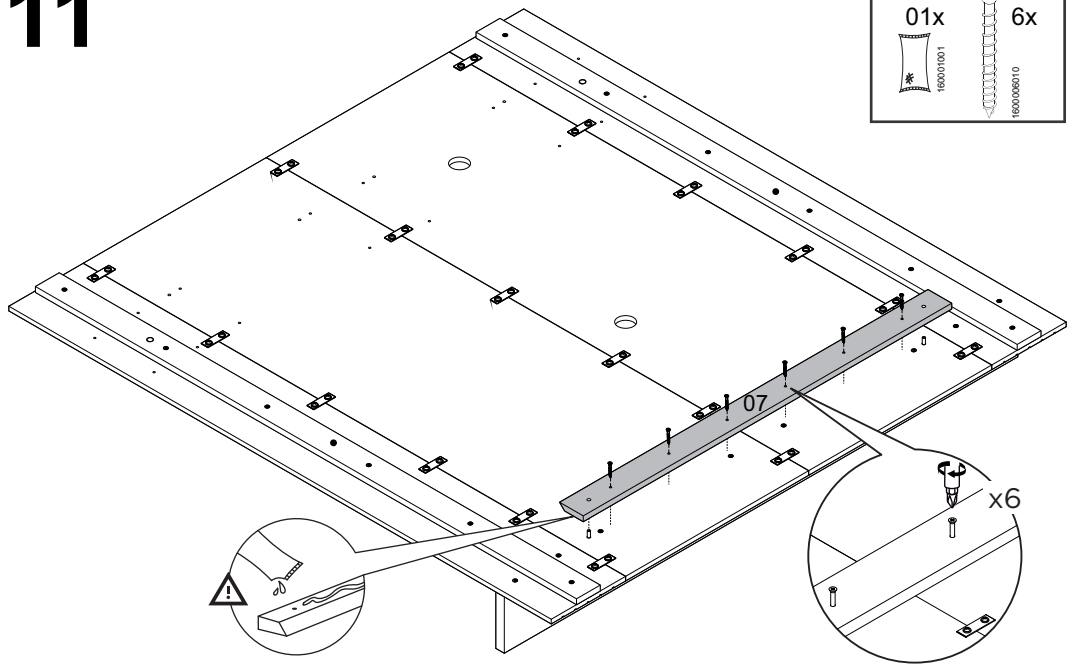

12

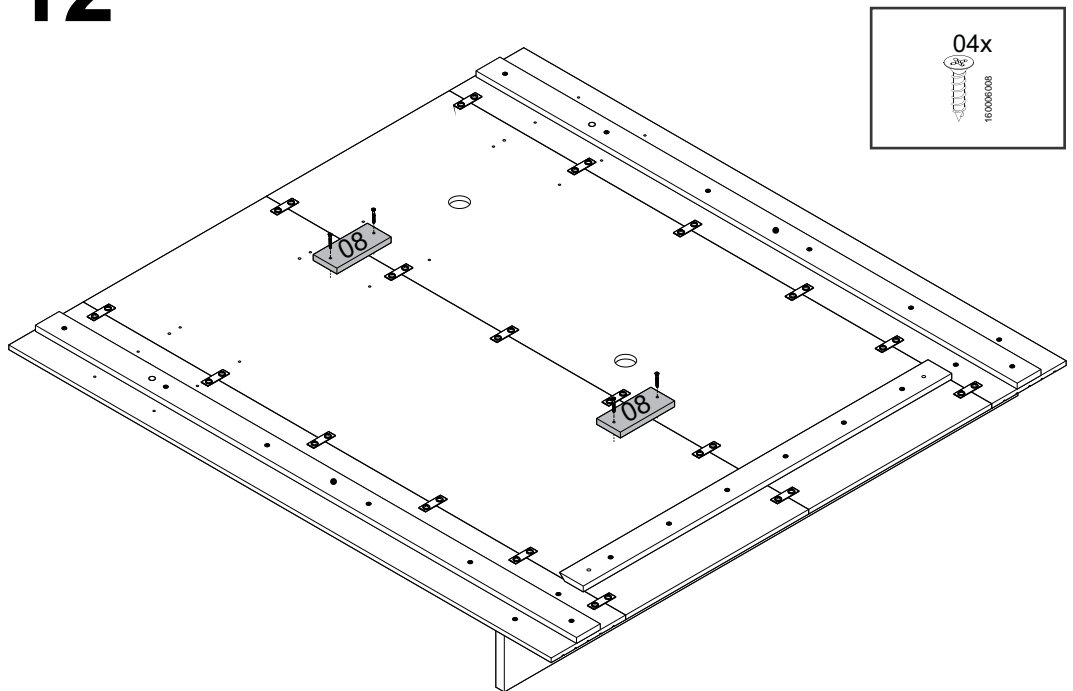

13

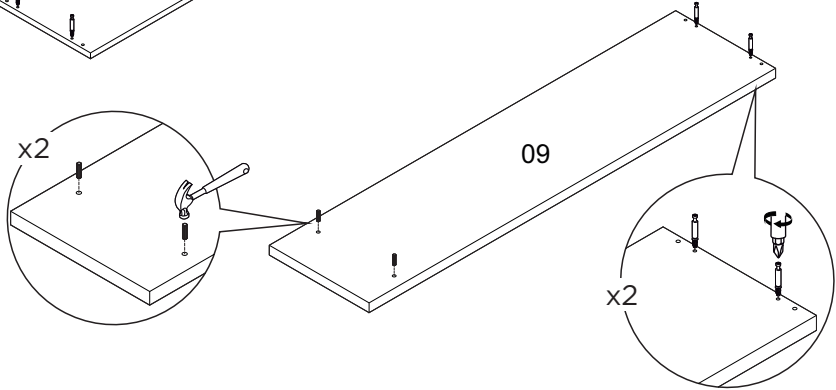
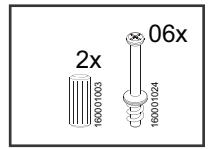
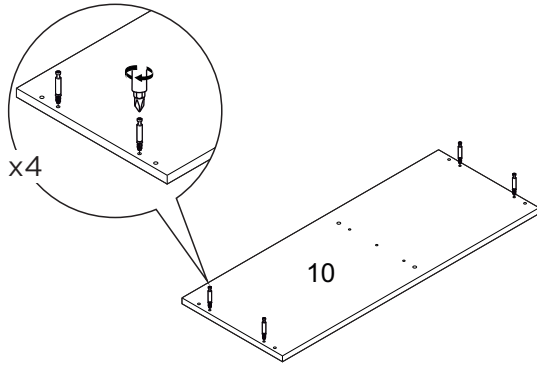

14

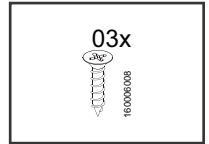
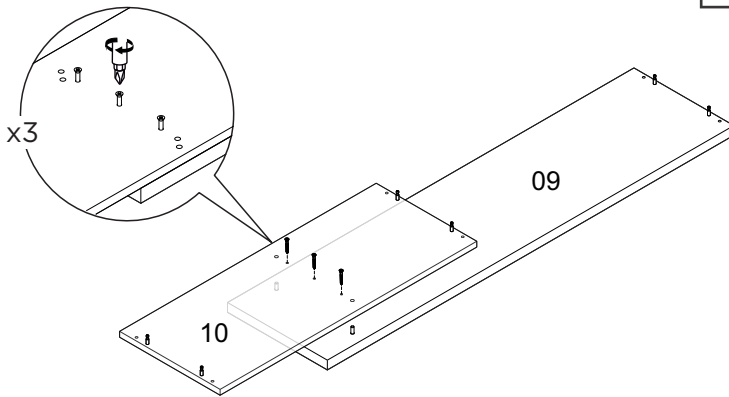

15

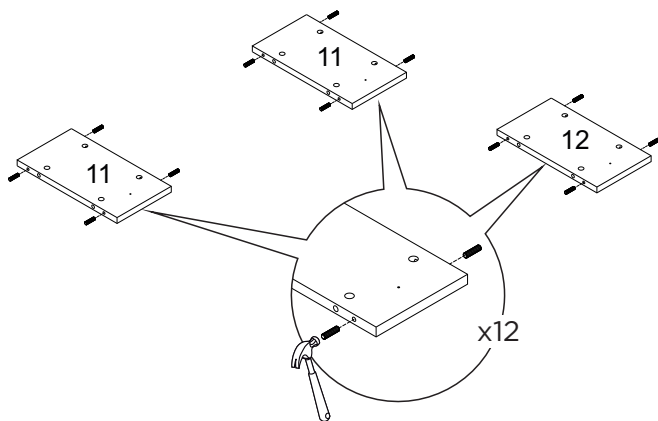
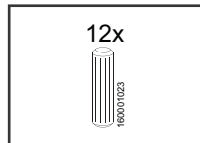

16

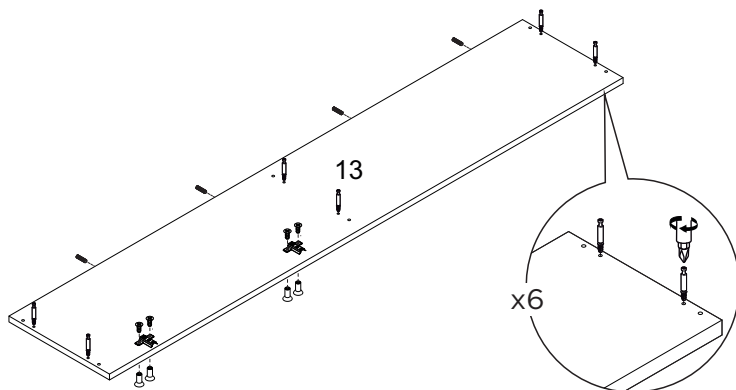
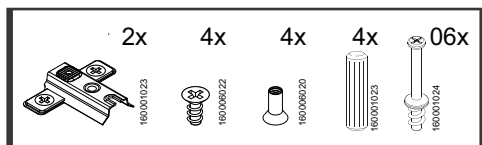

17

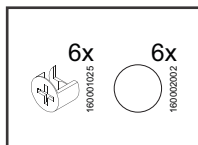
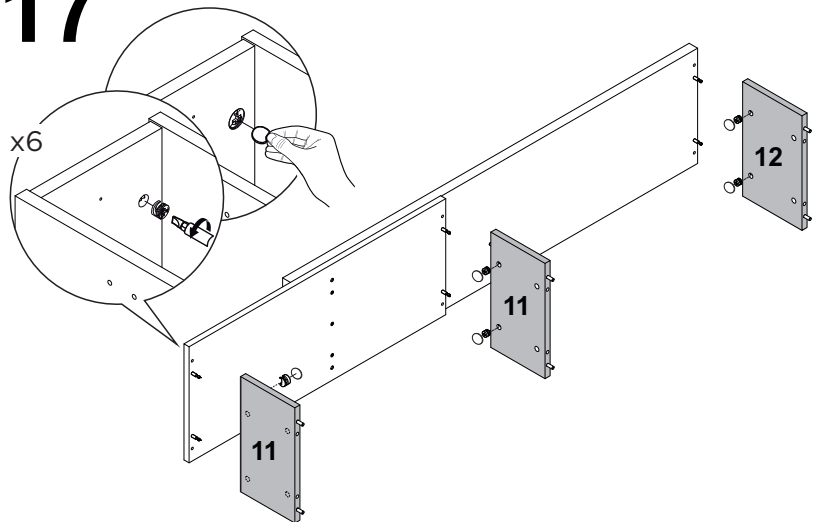

18

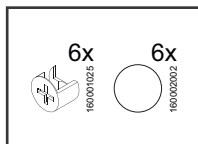
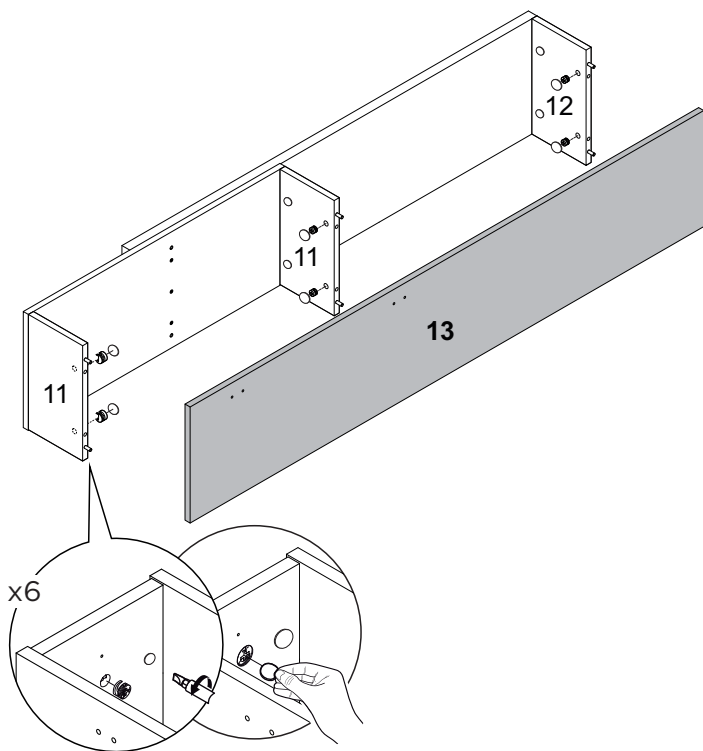

19

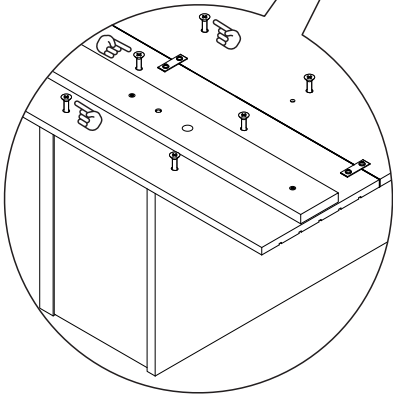
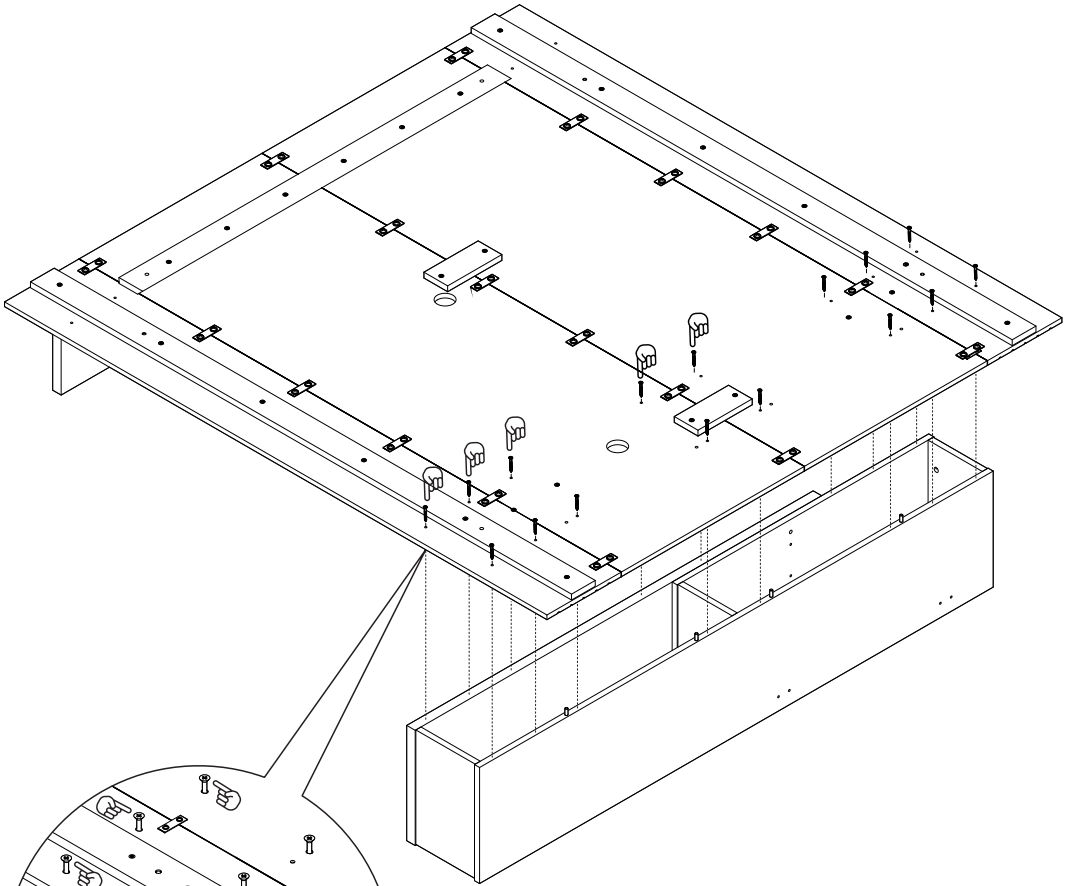
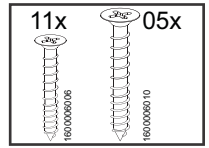

160006010

20

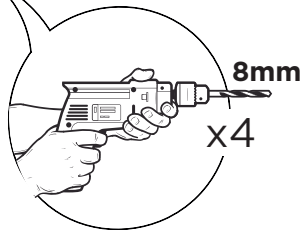
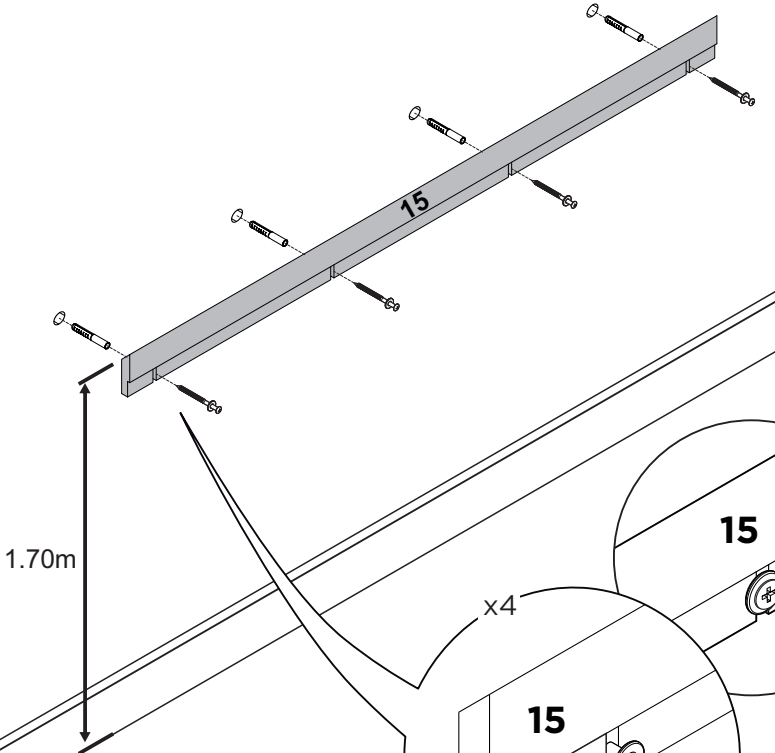
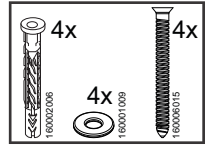

21

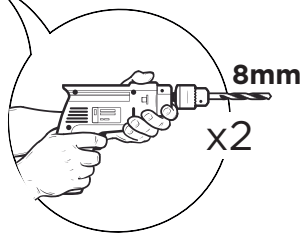
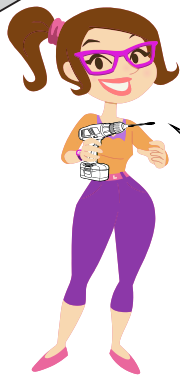
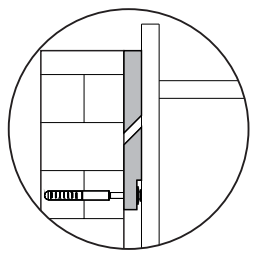
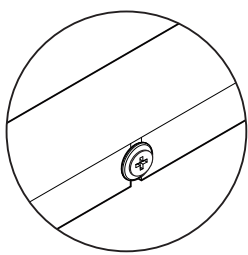
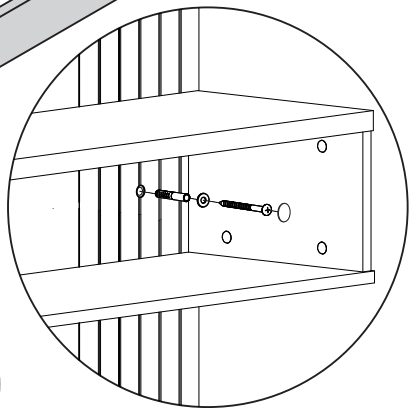
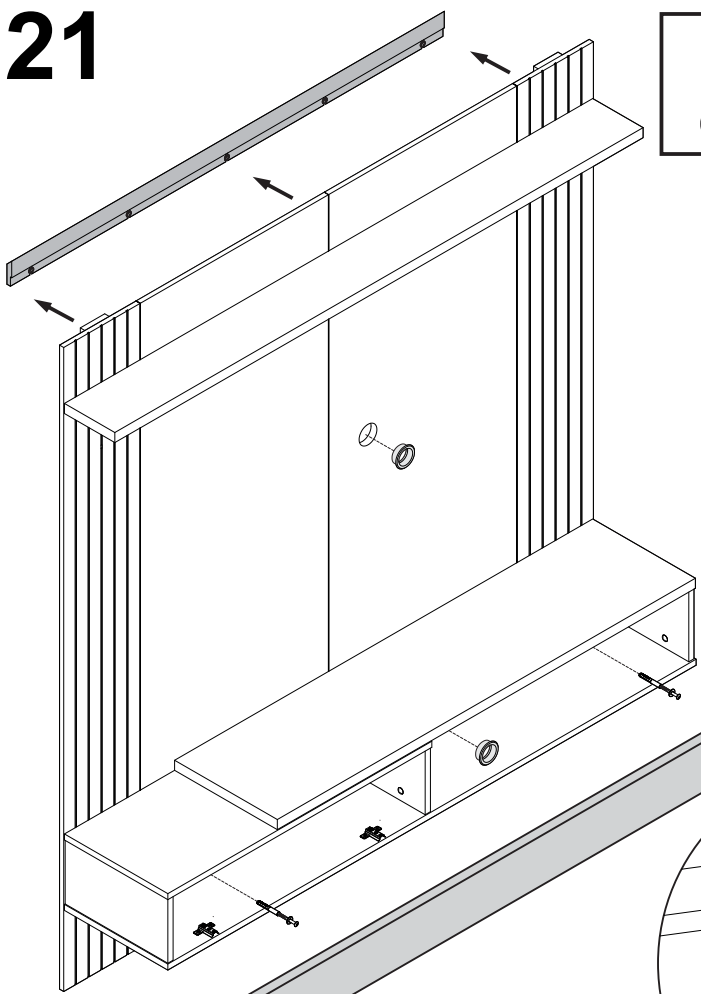
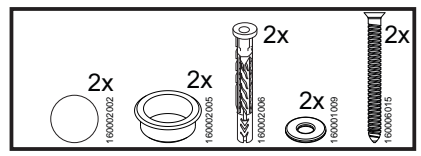

Verifique se a peça **Nº 15** está com uma boa fixação antes de encaixar o painel.

