

- Lista de Acessórios**
- Kit roldana (2 portas) 01
  - Cantoneira 4 furos 09
  - Cantoneira 06
  - Suporte angular 04
  - Sapata U 15mm 12
  - Preço 105
  - Suporte 04
  - Paraf. 3,5x12mm 102
  - Paraf. 3,5x12mm flangeado 08
  - Paraf. 3,5x25mm 10
  - Paraf. 3,5x35mm 12
  - Paraf. 4,0x40mm (Gavetas) 12
  - Paraf. 4,5x50mm 36
  - Oblongo 325mm 01
  - Oblongo 655mm 01
  - Cavilha 6 x 30mm 12
  - Minifix 12mm 16
  - Porca cilíndrica 36
  - Puxador aluminio 02
  - Suporte prateleira 12
  - Correção 03

**Lista de Peças**

Número	Descrição	Qtde	Número	Descrição	Qtde
01	Rodapé frontal	01	16	Chapéu	01
02	Rodapé traseiro	01	17	Batente lateral	02
03	Rodapé central	01	18	Frontal	01
04	Base	01	19	Suporte gaveta	04
05	Lateral esquerda	01	20	Frete gaveta	03
06	Divisória esquerda	01	21	Lateral gaveta	06
07	Divisória direita	01	22	Contra fundo gaveta	03
08	Lateral direita	01	23	Fundo gaveta	03
09	Prateleira inf. esquerda	01	24	Porta	02
10	Prateleira sup. esquerda	01	25	Fundo	04
11	Prateleira inf. central	01			
12	Prateleira móvel	03			
13	Prateleira sup. central	01			
14	Prateleira inf. direita	01			
15	Prateleira sup. direita	04			

- 
- 1) Identifique as peças;
  - 2) Coloque-as de pé;
  - 3) Utilize a embalagem no chão para não riscar as peças.

**MiraRack**  
VALORIZANDO SEU AMBIENTE  
www.mirarack.com.br - mirarack@mirarack.com.br  
Fone: 17-3243 8800

**LIMPEZA**

~~Álcool; Solventes; Acetona~~

Utilize: Pano seco e macio

01

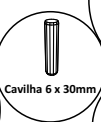
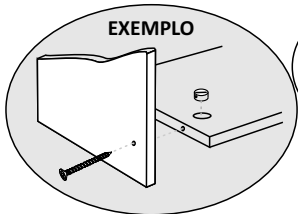
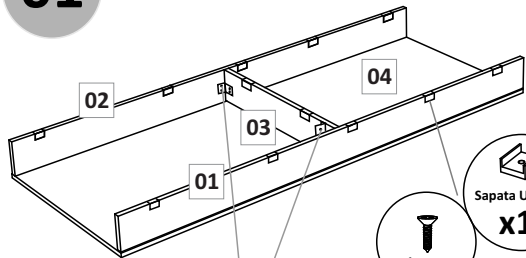

02

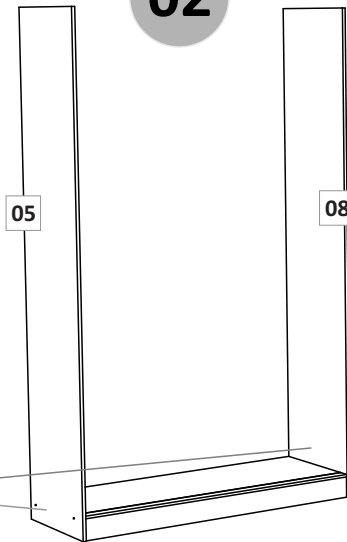

03

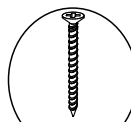
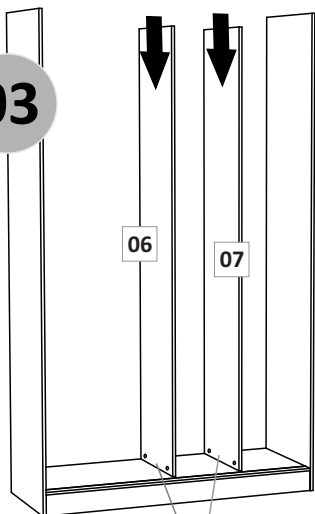

04

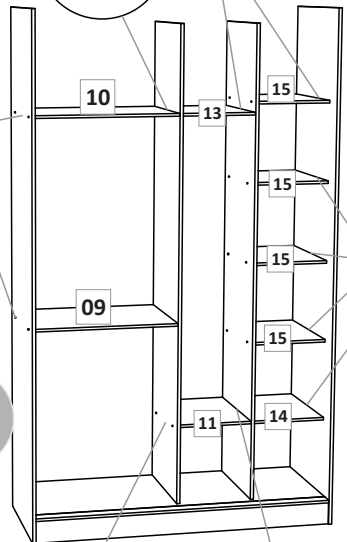

16

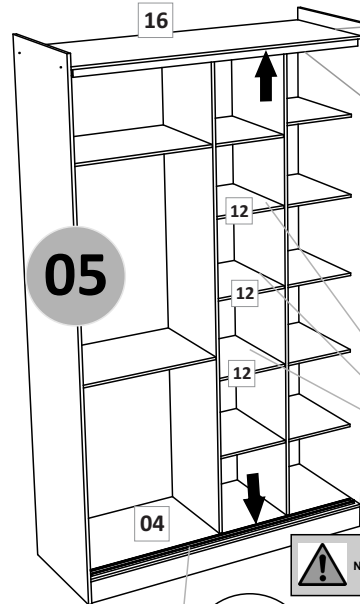

05



ALINHAR OS FUROS DO TRILHO NO CANAL NA BASE 04 E FIXAR OS PARAFUSOS.

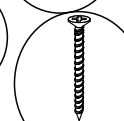

06

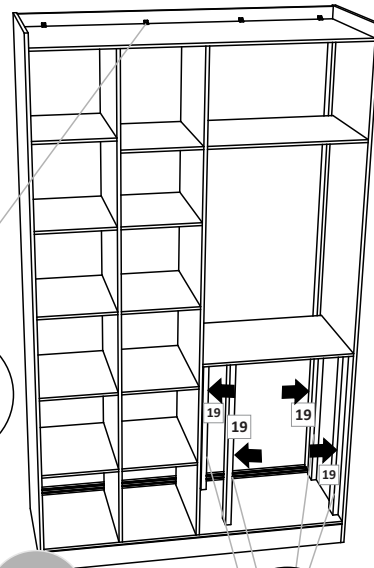

PELA PARTE TRASEIRA DO ROUPEIRO



07

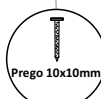
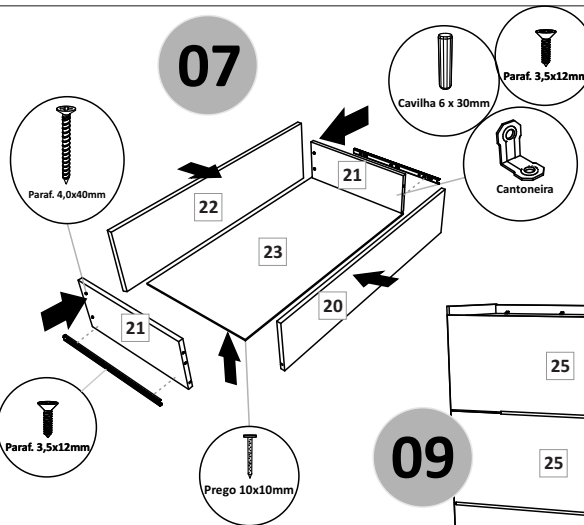

09

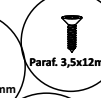
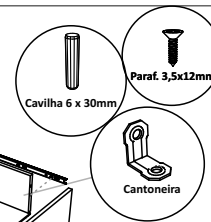

08

