



NOVO
HORIZ
ONTE

www.moveisnovohorizonte.com.br

MÓDULO AÉREO CASAL RIZON

ALT.: 2365mm | LARG.: 1670mm | PROF.: 565mm



CURTA NOSSA PÁGINA
NO FACEBOOK
LINK AO LADO (QR CODE)



FICHA TÉCNICA

PRODUTO 100% MDF
ACABAMENTO EM ALTO BRILHO ULTRAVIOLETA E HD
DOBRADIÇAS DE PRESSÃO 35mm

PARA ASSISTÊNCIA TÉCNICA, INDICAR NOME,
CÓDIGO E COR DA PEÇA.







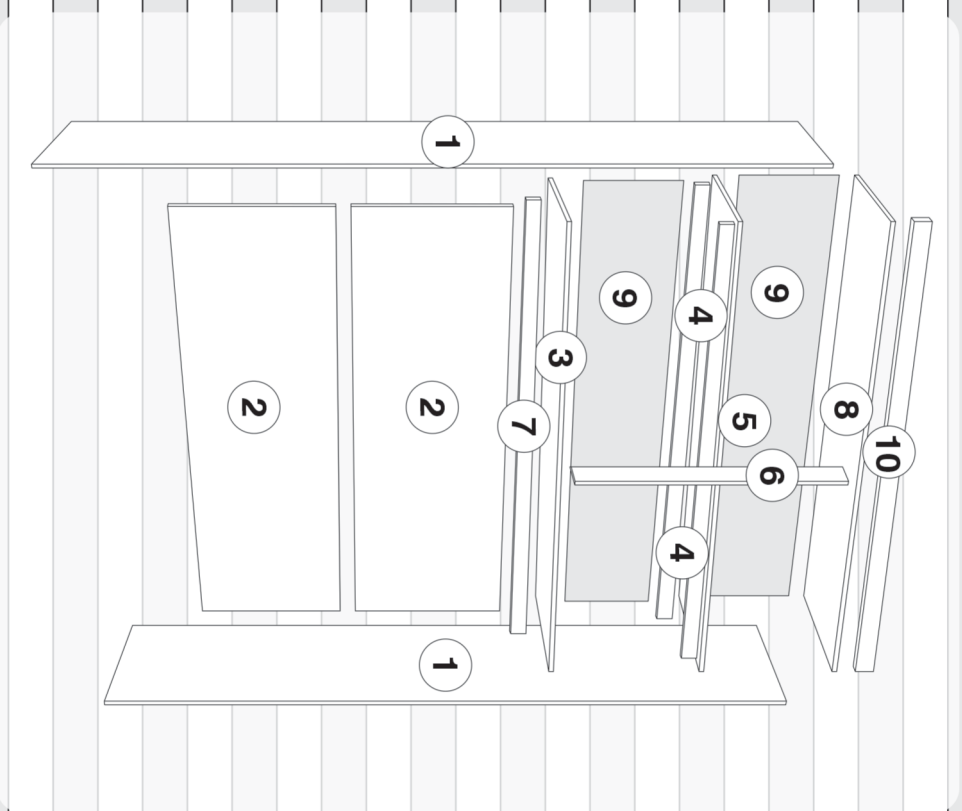



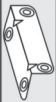
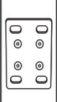

PARA SOLICITAR FERRAGENS, UTILIZE A
LISTA DA PÁGINA 3.

RELAÇÃO / QUANTIDADE DE PEÇAS

CÓDIGO	Nº	DESCRIÇÃO DAS PEÇAS	COMPR.	LARG.	QUANT.
14352	01	LATERAL	2364	540	02
14361	02	PAINEL CABECEIRA	1646	540	02
14354	03	BASE	1646	540	01
14360	04	TRAVESSA PRATELEIRA	1646	60	02
14355	05	PRATELEIRA	1646	442	01
14356	06	DIVISÃO	778	98	01
14359	07	TRAVESSA BASE	1646	60	01
14353	08	TAMPO	1646	540	01
14358	09	COSTAS	1668	401	02
14363	10	MOLDURA SUPERIOR	1671	60	01
14362	11	PORTA	860	412	04



RELAÇÃO / QUANTIDADE DE FERRAGENS

CÓDIGO		LETRA		DESCRÇÃO DAS FERRAGENS	QUANT.
2272	A			 PARAFUSO 5x40 PHI	30
3879	F2			 CALÇO PARA DOBRADIÇA	08
1409	E9			 DOBRADIÇA 35mm	08
1453	D9			 CANTONEIRA 4 FURROS	04
14868	H7			 CHATA RETA 4 FURROS	04
14699	C6			 PREGO 8 X 8	50
1117	E2			 SAPATA PLÁSTICA 15x15	04
1158	E6			 GIZ	02
1422	F			 PARAFUSO 3,5x35 CHATA PHI	08
3376	B8			 PARAFUSO UNIÃO M4x22 FEMEA CHATA	04
14754	B9			 PARAFUSO UNIÃO M4x12 MACHO CHATA	04
2041	M			 PARAFUSO 3,5x12 CHATA PHI	71
14421	T7			 FIXADOR DE COSTAS METÁLICO	15
12342	Z5			 TAPA FURO ADESIVO 17mm	46

NECESSÁRIO PARA MONTAGEM

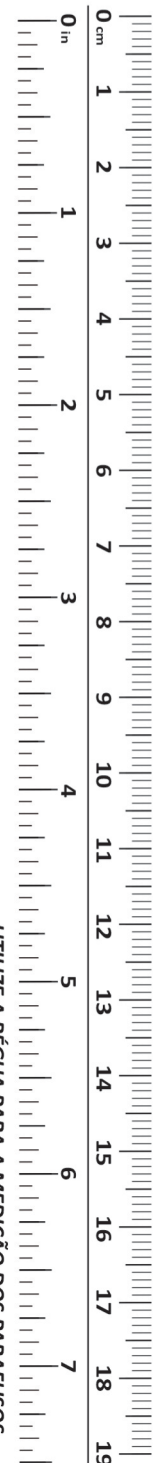
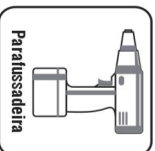
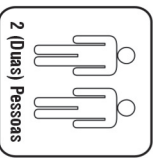

UTILIZE A RÉGUA PARA A MEDIÇÃO DOS PARAFUSOS

① PARAFUSAR PAINEL CABECEIRA.

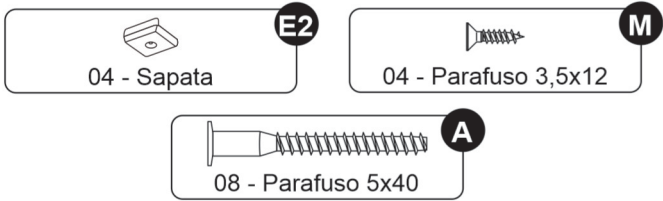
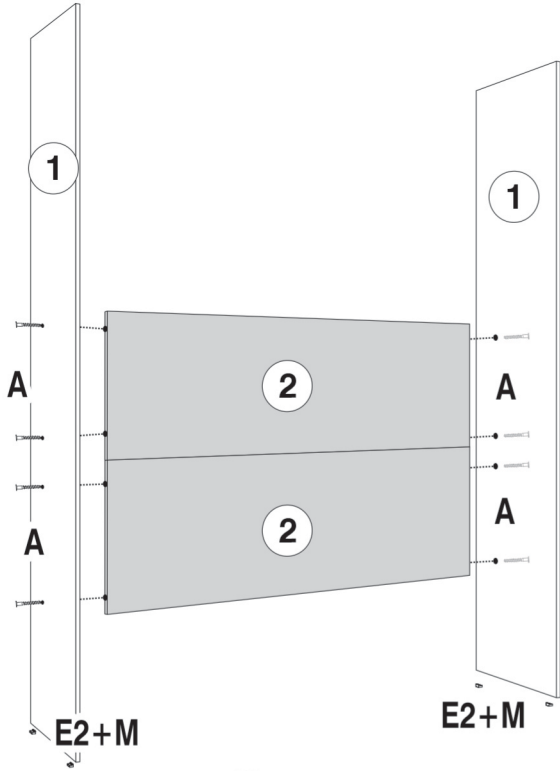

② UNIR PAINÉIS CABECEIRA.

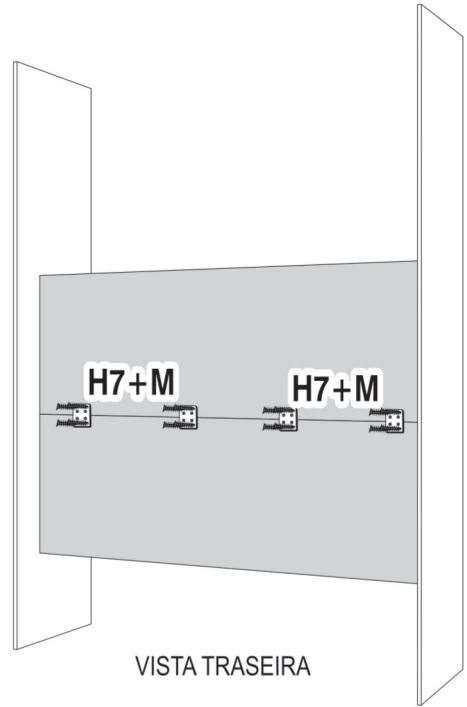

③ PARAFUSAR BASE.

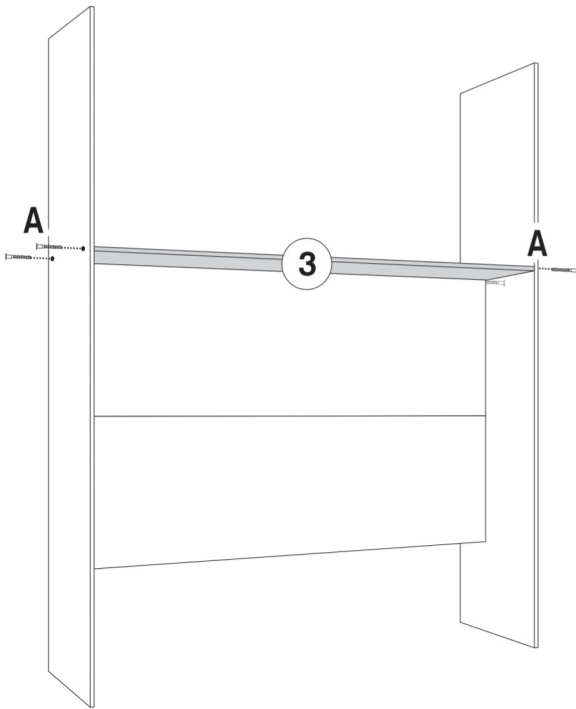

④ PARAFUSAR TRAVESSAS PRATELEIRA E PRATELEIRA.

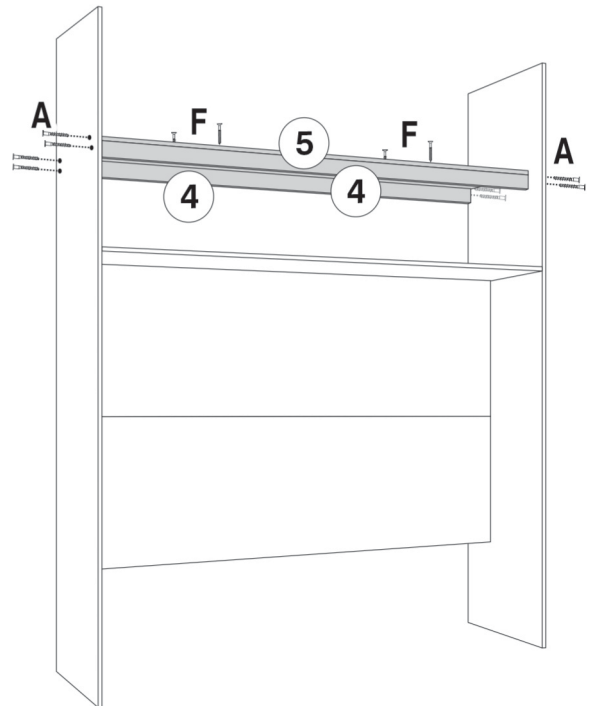

⑤ PARAFUSAR DIVISÃO.

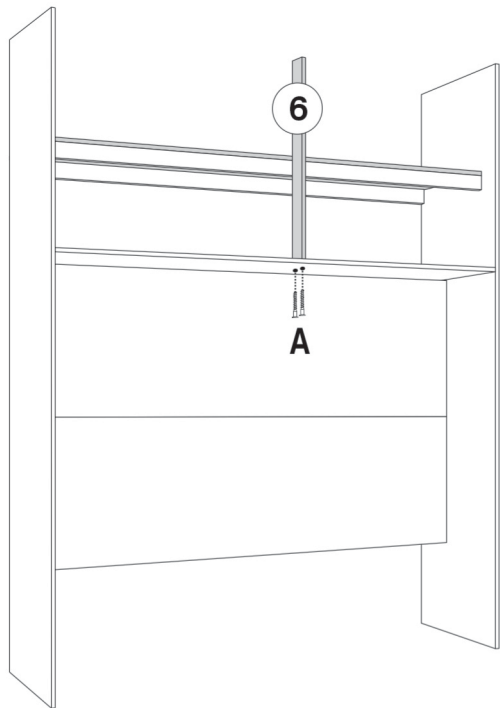

⑥ PARAFUSAR TRAVESSA BASE.

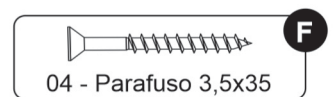
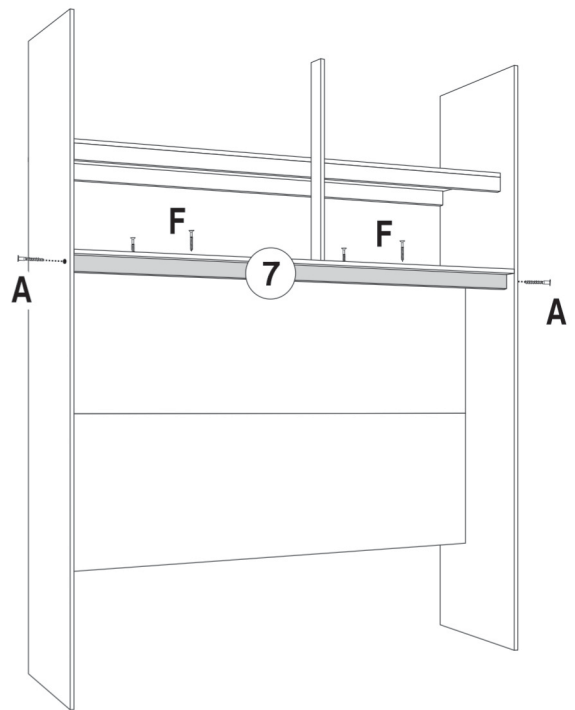

⑦ MONTAR MOLDURA NO TAMPO.

ATENÇÃO: FIXAR A MOLDURA A 5,5cm COM CANTONEIRA 4 FUROS CONFORME DESENHO ABAIXO.

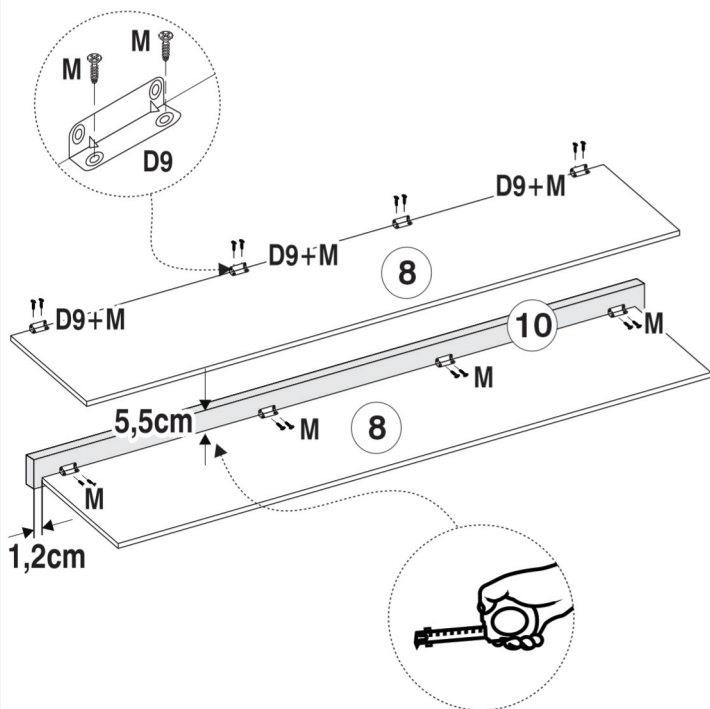

⑧ FIXAR TAMPO.

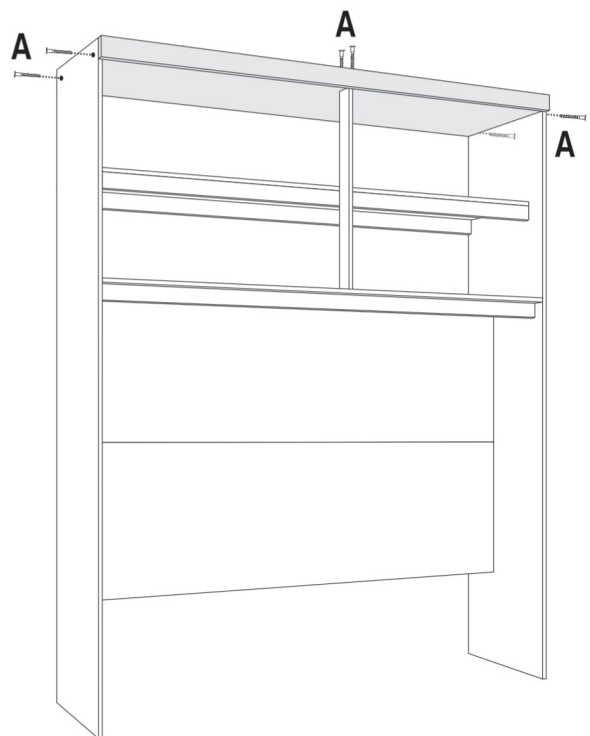

9 PREGAR AS COSTAS.

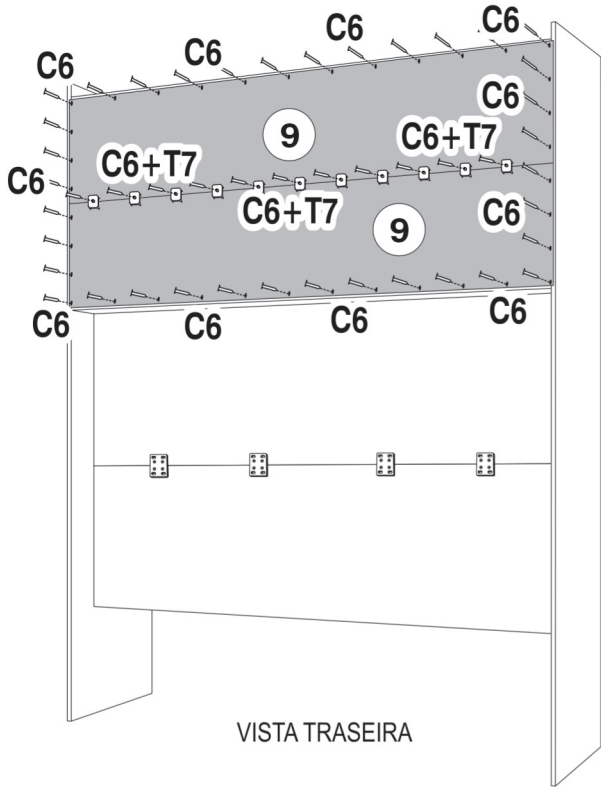

50 - PREGO 8x8

C6



15 - FIXADOR COSTAS

T7

10 MONTAR PORTAS.

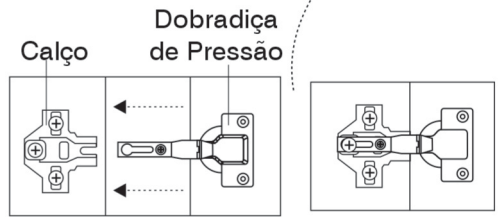
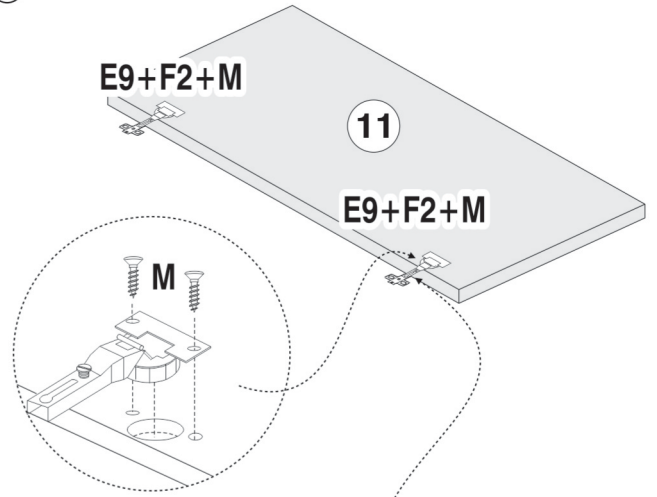

16 - PARAF. 3,5x12

M



08 - DOBRADIÇA PRESSÃO

E9



08 - CALÇO

F2

11 FIXAR AS PORTAS.

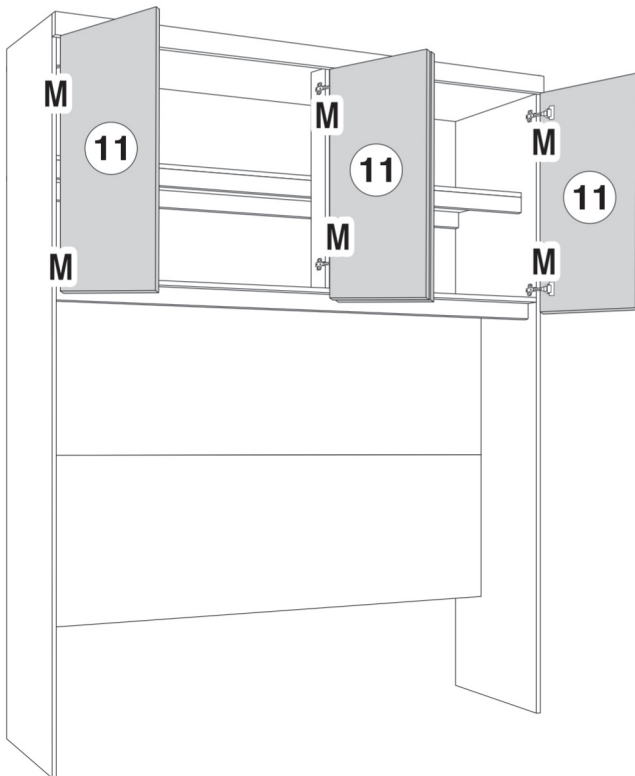

16 - PARAF. 3,5x12

M

12 PRODUTO MONTADO.

